

euro-block

product specification

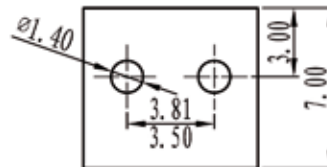
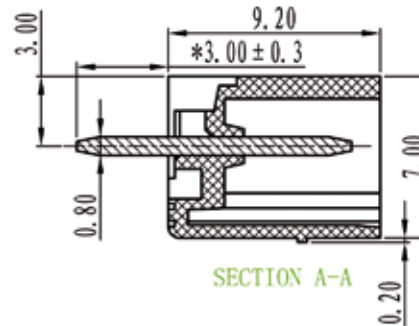
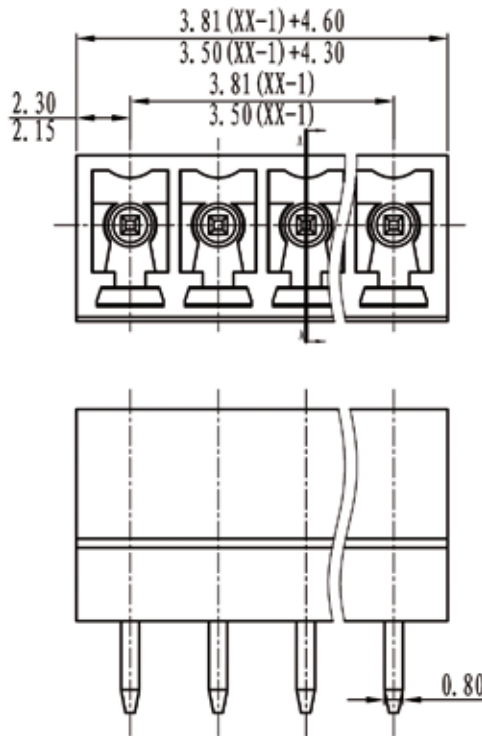

Electrical

Standard: UL-IEC
 Rated voltage: 125V-130V
 Rated current: 8A-7A
 Contact resistance: 20m Ω
 Withstanding voltage: AC2000V/1Min
 Insulation resistance: 5000M Ω/DC1000V

Mechanical

Temp.Range: -40°C~+105°C
 MAX soldering: +250°C, for 5 sec

Dimensions

Pitch: 3.81mm/3.50mm
 Poles: 2p-24p

Material

Housing: PA66, UL94V-0
 Pin header: Brass, Tin plated

TOLERANCES EXCEPT AS NOTED

variable range	linear dimension				fillet	chamfer	short angle sid				≡	-	□	//	⊥	
	to 6	over 6 to 30	over 30 to 120	over 120 to 480	all	over 6 to 6	to 10	over 10 to 50	over 50 to 120	to 120	all	to 5	over 5 to 30	over 30 to 120	over 120 to 120	
tolerance	±0.1	±0.2	±0.3	±0.5	±0.2	±0.5	±1	1'	30'	20'	10'	0.5	0.025	0.06	0.12	0.4

UNITS	mm	SIZE	A4	SCALE	FIRST ANGLE PROJECTION	
					NAME	CCM-3.5/3.81-CV